

# Automation/Robotic Tips

## Features

- Adopt medical grade polypropylene material, which is manufactured by precision mold, and the material batch is stable.
- DNase-and RNase-free, no heat source contamination.
- Electron beam sterilization.
- Manufacturing facility equipped with class 100,000 clean-room, products packing under sterile condition.
- Unique process technology ensures that the inner surface of the tip is smooth and reduces liquid residue.
- Carry out structural drawing and measurement according to the original adapter to ensure that the product has good air tightness and adaptability.
- Online testing equipment is used to control the size and concentricity of products in the production line.



**Effective quality inspections are conducted for strict quality management and control per the client's needs, including tests for DNase, RNase, proteases and pyrogens.**

### • Air Tightness Test

Precise equipment are used to test the air tightness between the tip and the adapter, to ensure good air tightness for each batch of products.

### • Tests for Resistance and Cv Values

A certain number of products are sampled for each batch for inspection, which is conducted using precise and unique measuring tools to ensure the accuracy and reliability of the test results to ensure the uniform conductivity of products.

### • Online equipment testing (≤3%)

Tests for Resistance and CV Values of Automation Conductive Tips.

## Clear Robotic Tips, Compatible with Agilent Systems

**NEW**

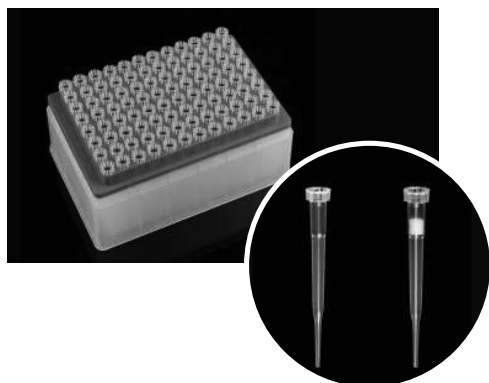

### Low-retention Tips, Boxed, Sterile

Low-retention tips are an excellent choice for transferring viscous liquid, which can effectively reduce the phenomenon of liquid hanging on the wall and make the experiment more accurate.

Cat.No.	Descriptions	/Pack	/Case
352003	30μL Robotic Tips for Agilent, Low-retention, Clear	384	19200
352103	70μL Robotic Tips for Agilent, Low-retention, Clear	384	19200
352203	250μL Robotic Tips for Agilent, Low-retention, Clear	96	4800
352213	250μL Robotic <b>Filter</b> Tips for Agilent, Low-retention, Clear	96	4800

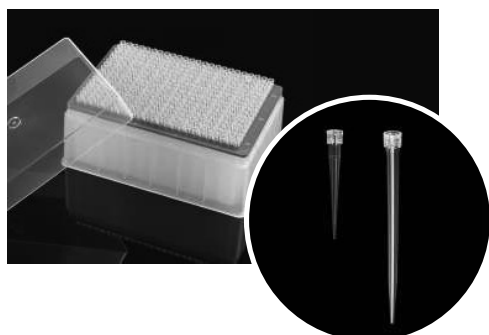

### Boxed, Sterile

Cat.No.	Descriptions	/Pack	/Case
352002	30μL Robotic Tips for Agilent, Clear	384	19200
352102	70μL Robotic Tips for Agilent, Clear	384	19200
352202	250μL Robotic Tips for Agilent, Clear	96	4800
352212	250μL Robotic <b>Filter</b> Tips for Agilent, Clear	96	4800

## Conductive Tips, Compatible with Tecan Systems

TECAN automation conductive tips may be used with the TECAN Freedom EVOlyzers and fully automatic sampling systems.

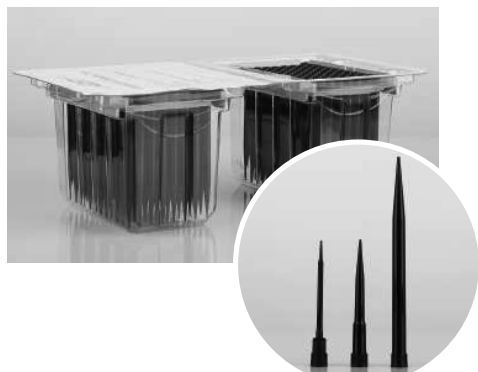

### Blister Packed, 96 tips \*2 Blisters/Pk, Sterile

Cat.No.	Descriptions	/Pack	/Case
332002	50 µL Robotic Conductive Tips for Tecanr, Blister Packed	96*2	2304
332102	200 µL Robotic Conductive Tips for Tecanr, Blister Packed	96*2	2304
332202	1000 µL Robotic Conductive Tips for Tecanr, Blister Packed	96*2	2304
332012	50 µL Robotic Conductive <b>Filter</b> Tips for Tecanr, Blister Packed	96*2	2304
332112	200 µL Robotic Conductive <b>Filter</b> Tips for Tecanr, Blister Packed	96*2	2304
332212	1000 µL Robotic Conductive <b>Filter</b> Tips for Tecanr, Blister Packed	96*2	2304

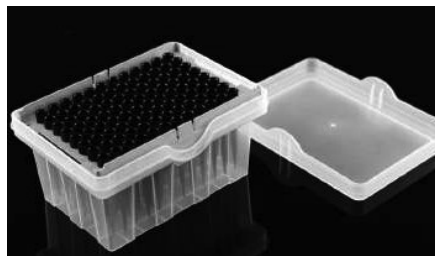

### Boxed, 96 Tips/Pk, Sterile **NEW**

Cat.No.	Descriptions	/Pack	/Case
332016	50 µl Robotic <b>Filter</b> Tips for Tecan, Conductive	96	4800
332116	200 µl Robotic <b>Filter</b> Tips for Tecan, Conductive	96	4800
332216	1000 µl Robotic <b>Filter</b> Tips for Tecan, Conductive	96	4800

## Clear Robotic Tips, Compatible with Tecan Systems

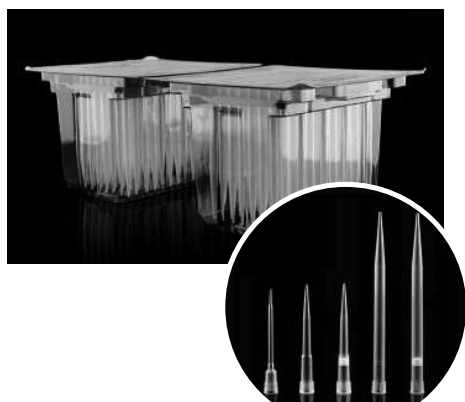

### Blister Packed, 96 Tips\*2 Blisters/Pk, Sterile

Cat.No.	Descriptions	/Pack	/Case
332003	50 µl Robotic Tips for Tecan, Clear, Blister Packed	96*2	5760
332013	50 µl Robotic <b>Filter</b> Tips for Tecan, Clear, Blister Packed	96*2	5760
332103	200 µl Robotic Tips for Tecan, Clear, Blister Packed	96*2	5760
332113	200 µl Robotic <b>Filter</b> Tips for Tecan, Clear, Blister Packed	96*2	5760
332203	1000 µl Robotic Tips for Tecan, Clear, Blister Packed	96*2	3840
332213	1000 µl Robotic <b>Filter</b> Tips for Tecan, Clear, Blister Packed	96*2	3840



### Boxed, 96 Tips/Pk, Sterile

Cat.No.	Descriptions	/Pack	/Case
332007	50 µl Robotic Tips for Tecan, Clear, Boxed	96	4800
332017	50 µl Robotic <b>Filter</b> Tips for Tecan, Clear, Boxed	96	4800
332107	200 µl Robotic Tips for Tecan, Clear, Boxed	96	4800
332117	200 µl Robotic <b>Filter</b> Tips for Tecan, Clear, Boxed	96	4800
332207	1000 µl Robotic Tips for Tecan, Clear, Boxed	96	4800
332217	1000 µl Robotic <b>Filter</b> Tips for Tecan, Clear, Boxed	96	4800

# Automation/Robotic Tips

## Conductive Tips, Compatible with Hamilton Systems

Hamilton automation conductive tips may be used with these workstations: Hamilton Nimbus, Hamilton Startlet, Hamilton Star, Hamilton Vantage.

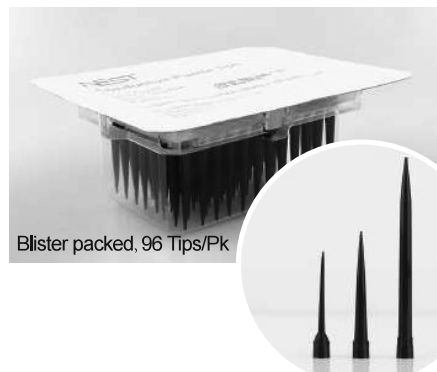

Blister packed, 96 Tips/Pk

### Without Barcode, Blister Packed, 96 Tips/Pk, Sterile

NEST Cat.No.	Descriptions	/Pack	/Case
345002	50 µL Robotic Conductive Tips for Hamilton	96	2304
345102	300 µL Robotic Conductive Tips for Hamilton	96	2304
345202	1000 µL Robotic Conductive Tips for Hamilton	96	2304
345012	50 µL Robotic Conductive <b>Filter</b> Tips for Hamilton	96	2304
345112	300 µL Robotic Conductive <b>Filter</b> Tips for Hamilton	96	2304
345212	1000 µL Robotic Conductive <b>Filter</b> Tips for Hamilton	96	2304



With barcode means  
there is a barcode on the rack

### With Barcode, Blister Packed, 96 Tips\*5 Blisters/Pk, Sterile

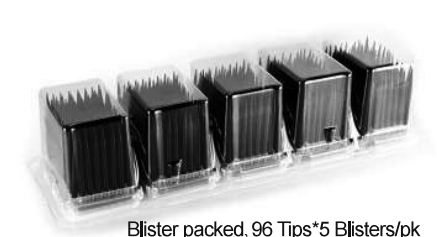

Blister packed, 96 Tips\*5 Blisters/pk

Cat.No.	Descriptions	/Pack	/Case
345015	50 µL Robotic Conductive <b>Filter</b> Tips for Hamilton, with Barcode	96*5	5760
345005	50 µL Robotic Conductive Tips for Hamilton, with Barcode	96*5	5760
345115	300 µL Robotic Conductive <b>Filter</b> Tips for Hamilton, with Barcode	96*5	5760
345105	300 µL Robotic Conductive Tips for Hamilton, with Barcode	96*5	5760
345215	1000 µL Robotic Conductive <b>Filter</b> Tips for Hamilton, with Barcode	96*5	3840
345205	1000 µL Robotic Conductive Tips for Hamilton, with Barcode	96*5	3840



Blister packed, 96 Tips/Pk

### With Barcode, Blister Packed, 96 Tips/Pk, Sterile

Cat.No.	Descriptions	/Pack	/Case
345013	50 µL Robotic Conductive <b>Filter</b> Tips for Hamilton, with Barcode	96	2304
345113	300 µL Robotic Conductive <b>Filter</b> Tips for Hamilton, with Barcode	96	2304
345213	1000 µL Robotic Conductive <b>Filter</b> Tips for Hamilton, with Barcode	96	2304

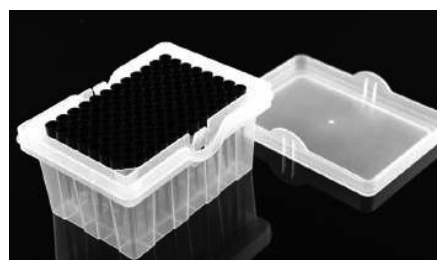

### With Barcode, Boxed, 96 Tips/Pk, Sterile **NEW**

Cat.No.	Descriptions	/Pack	/Case
345069	50 µL Robotic Conductive <b>Filter</b> Tips for Hamilton, with Barcode	96	4800
345169	300 µL Robotic Conductive <b>Filter</b> Tips for Hamilton, with Barcode	96	4800
345269	1000 µL Robotic Conductive <b>Filter</b> Tips for Hamilton, with Barcode	96	4800

# Automation/Robotic Tips

## Clear Robotic Tips, Compatible with Hamilton Systems



With Barcode, Blister Packed, 96 Tips/Pk, Sterile

Cat.No.	Descriptions	/Pack	/Case
345503	50 µl Robotic Tips for Hamilton, Clear, with barcode	96	2304
345513	50 µl Robotic <b>Filter</b> Tips for Hamilton, Clear, with barcode	96	2304
345603	300 µl Robotic Tips for Hamilton, Clear, with barcode	96	2304
345613	300 µl Robotic <b>Filter</b> Tips for Hamilton, Clear, with barcode	96	2304
345703	1000 µl Robotic Tips for Hamilton, Clear, with barcode	96	2304
345713	1000 µl Robotic <b>Filter</b> Tips for Hamilton, Clear, with barcode	96	2304



With Barcode, Boxed, 96 Tips/Pk, Sterile **NEW**

Cat.No.	Descriptions	/Pack	/Case
345509	50 µl Robotic Tips for Hamilton, Clear, with barcode	96	4800
345519	50 µl Robotic <b>Filter</b> Tips for Hamilton, Clear, with barcode	96	4800
345609	300 µl Robotic Tips for Hamilton, Clear, with barcode	96	4800
345619	300 µl Robotic <b>Filter</b> Tips for Hamilton, Clear, with barcode	96	4800
345709	1000 µl Robotic Tips for Hamilton, Clear, with barcode	96	4800
345719	1000 µl Robotic <b>Filter</b> Tips for Hamilton, Clear, with barcode	96	4800

## Clear Robotic Tips, Compatible with Beckman Systems

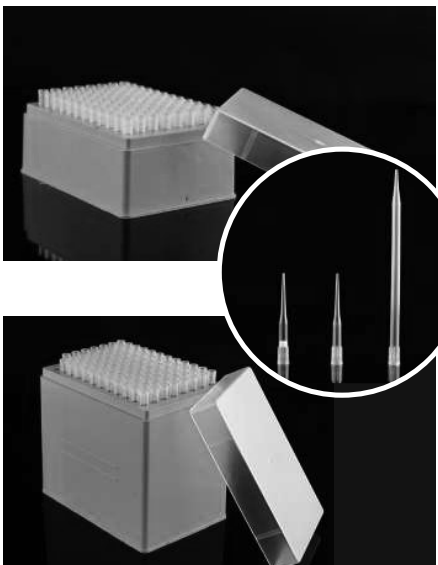

Boxed, 96 Tips/Pk, Sterile

Cat.No.	Descriptions	/Pack	/Case
317511	250 µL Robotic Tips for Beckman, Clear	96	4800
317011	1070 µL Robotic Tips for Beckman, Clear	96	4800
317501	190 µL Robotic <b>Filter</b> Tips for Beckman, Clear	96	4800
317101	1000 µL Robotic <b>Filter</b> Tips for Beckman, Clear	96	4800